

OUTLINE DIMENSIONAL DRAWING

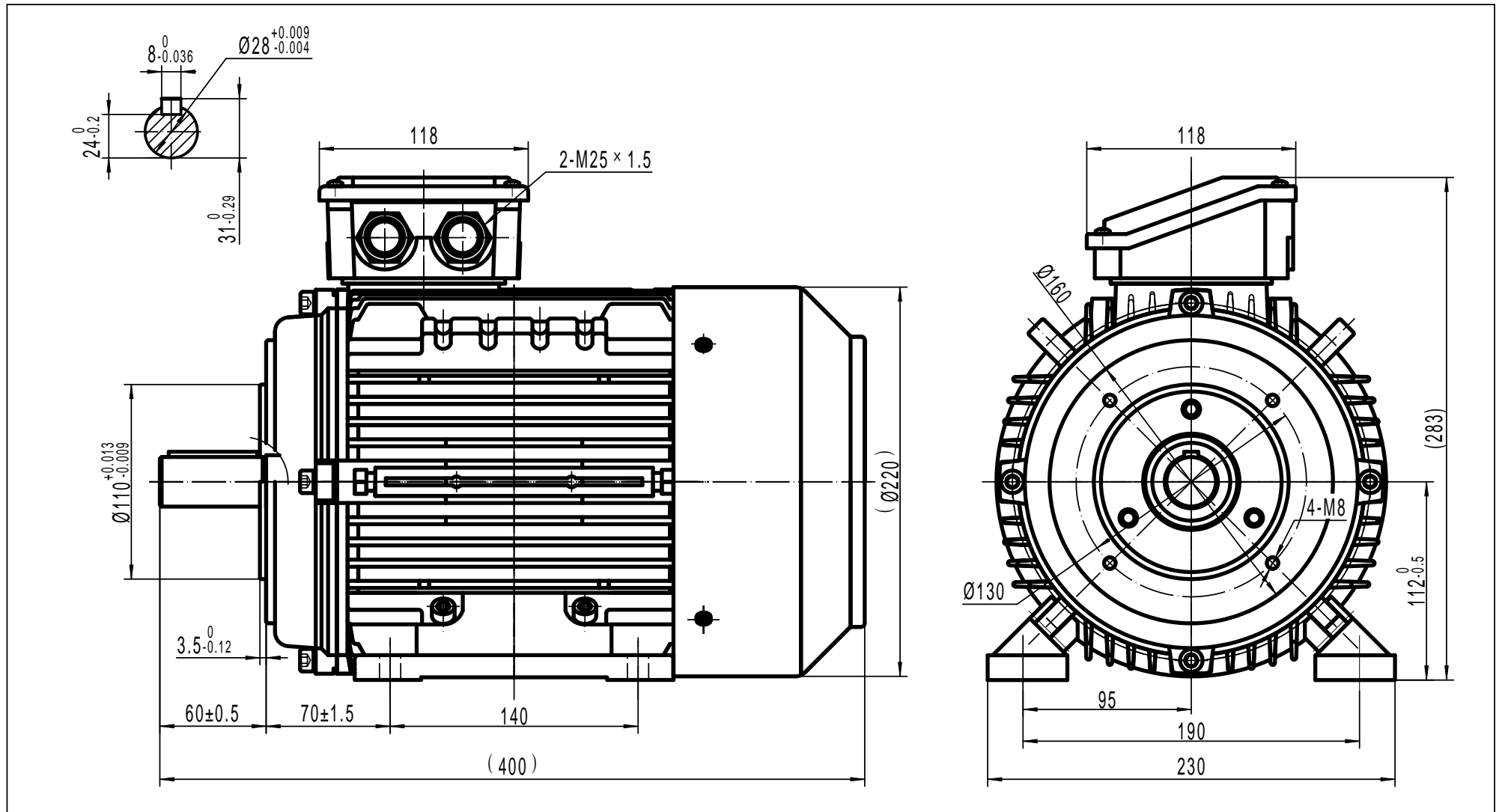

TECHTOP AUSTRALIA PTY LTD	
FRAME	TAI 112A B34
DATE	DRAWING NO.
2011/10/14	1ST086.052.001-024 A